

By All Means

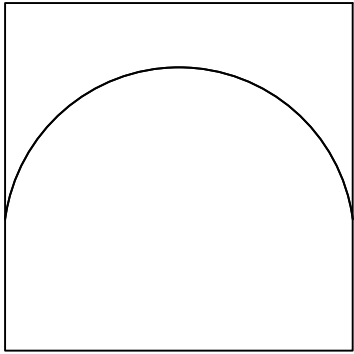

COLOR & FINISH SELECTION:

Color A: _____

Color B: _____

Color C: _____

Color D: _____

PATTERN SELECTION:

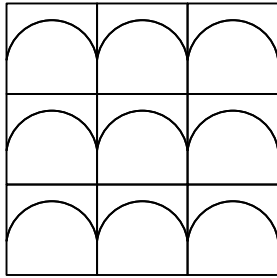

Pattern A - Straight Pattern

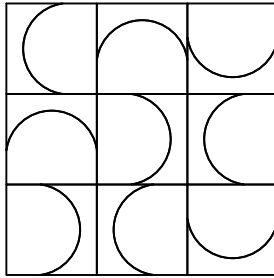

Pattern B - Randomly Rotate

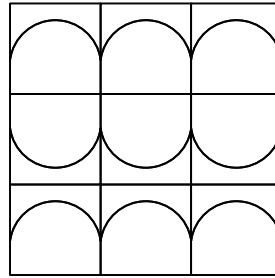

Pattern C - Rotate every other row

SCALE SELECTION:

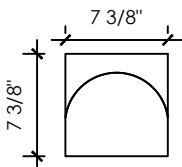

Petite (0.38 sf/ea)

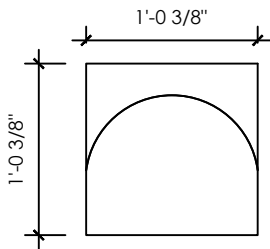

Modest (1.07 sf/ea)

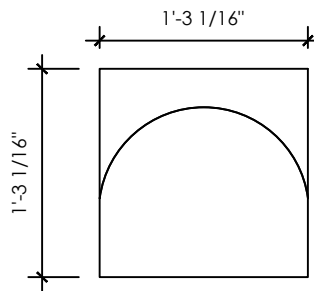

Grande (1.57 sf/ea)

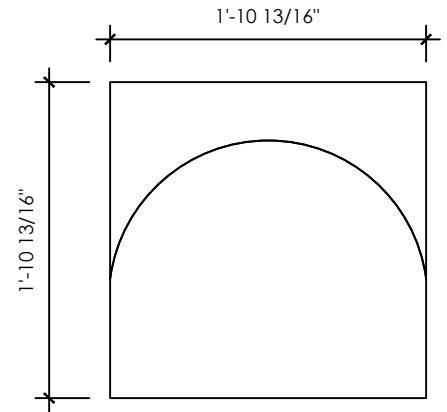

Titan (3.62 sf/ea)

SPECIAL NOTES:

Project Name:

Revision Date:

Revision ID:

Location:

Area:

Representative:

Install Pattern:

Units:

Rep Email:

Scale:

Total Area:

Notes: Images are not drawn to scale