

Key To My Heart

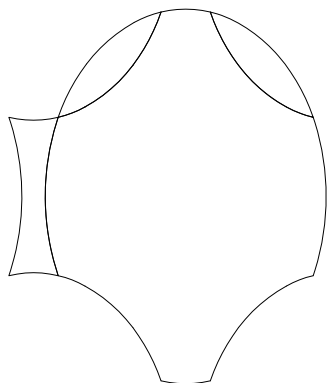

COLOR & FINISH SELECTION:

Color A: _____ Matte
Polished

Color B: _____ Matte
Polished

PATTERN SELECTION:

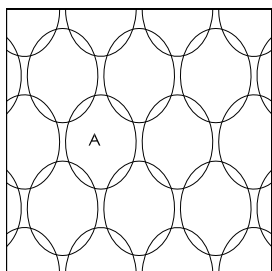

Pattern A - 1 Color

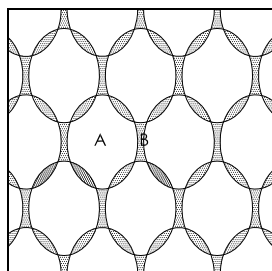

Pattern B - 2 Color

SCALE SELECTION:

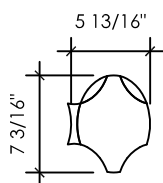

Petite

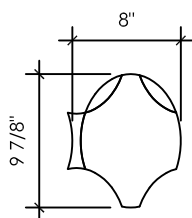

Modest

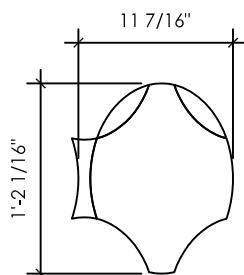

Grande

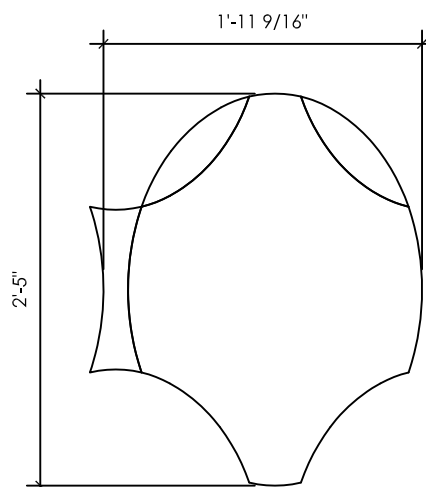

Titan

SPECIAL NOTES:

Project Name:

Revision Date:

Revision ID:

Location:

Area:

Representative:

Install Pattern:

Units:

Rep Email:

Scale:

Total Area:

Notes: Images are not drawn to scale