

Word Of Mouth

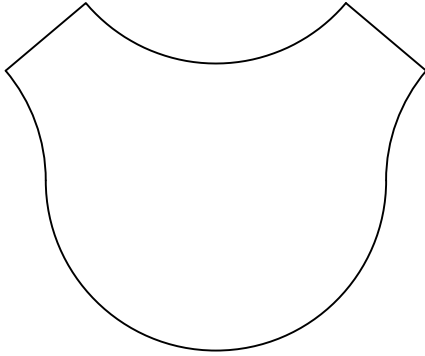

COLOR & FINISH SELECTION:

Color A: _____

Color B: _____

Color C: _____

Color D: _____

PATTERN SELECTION:

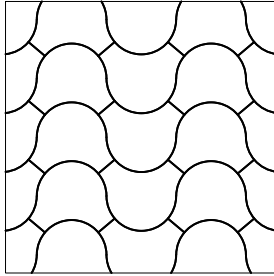

Pattern A - 1 Color

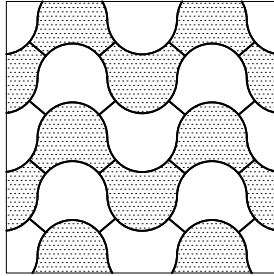

Pattern B - Checkerboard
2 or more colors

SCALE SELECTION:

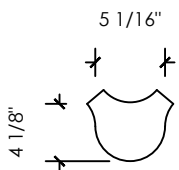

Petite
(0.60 sf/sheet, 4 pcs/sheet)

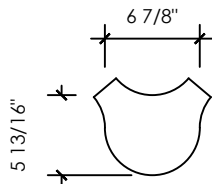

Modest (0.275 sf/ea)

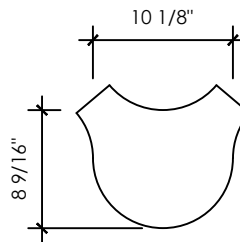

Grande (0.6 sf/ea)

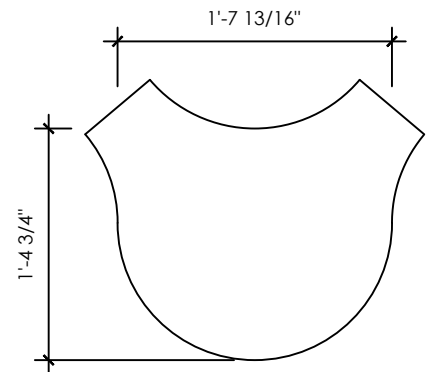

Titan (2.305 sf/ea)

SPECIAL NOTES:

Project Name:

Revision Date:

Revision ID:

Location:

Area:

Representative:

Install Pattern:

Units:

Rep Email:

Scale:

Total Area:

Notes: Images are not drawn to scale