

Clarity

COLOR & FINISH SELECTION:

Color A: _____ Matte
 Polished

Color B: _____ Matte
 Polished

Color C: _____ Matte
 Polished

PATTERN SELECTION:

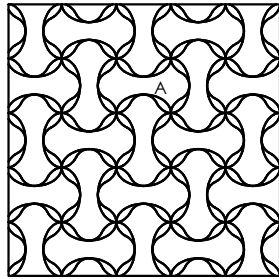

Pattern A

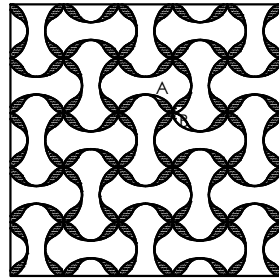

Pattern B - 2 Color

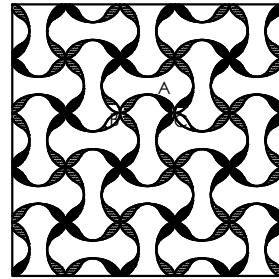

Pattern C - 3 Color

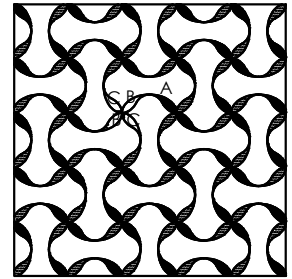

Pattern C - 3 Color

SCALE SELECTION:

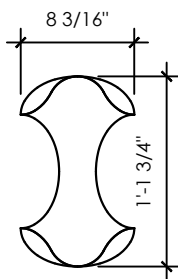

Petite

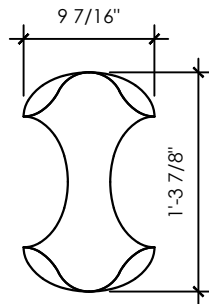

Modest

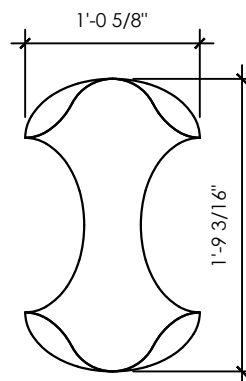

Grande

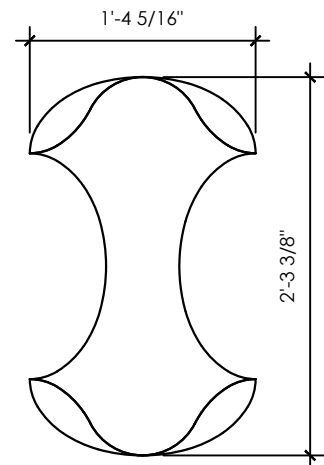

Titan

SPECIAL NOTES:

Project Name:

Revision Date:

Revision ID:

Location:

Area:

Representative:

Install Pattern:

Units:

Rep Email:

Scale:

Total Area:

Notes: Images are not drawn to scale