

Note To Self

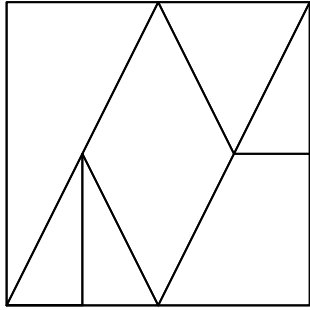

COLOR & FINISH SELECTION:

Color A: _____ Matte
 _____ Polished

Color B: _____ Matte
 _____ Polished

Color C: _____ Matte
 _____ Polished

Color D: _____ Matte
 _____ Polished

PATTERN SELECTION:

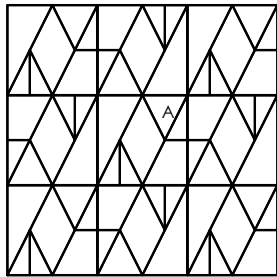

Pattern A - 1 Color

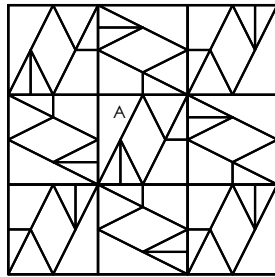

Pattern B - 1 Color

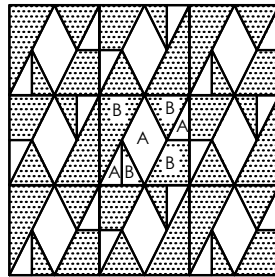

Pattern C - 2 Color

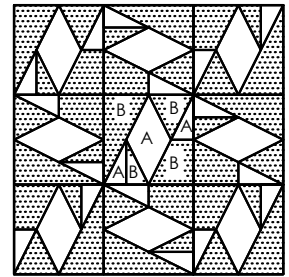

Pattern D - 2 Color

SCALE SELECTION:

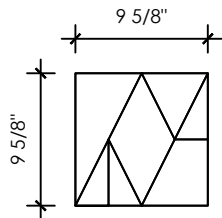

Petite

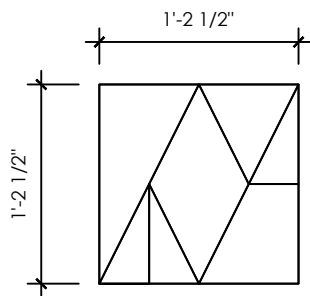

Modest

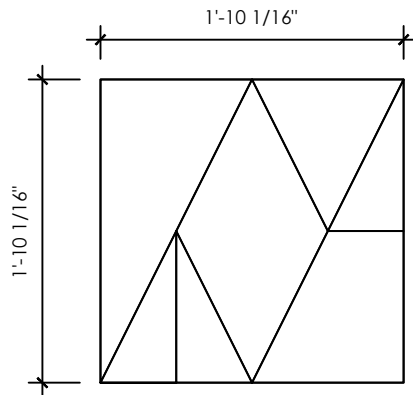

Grande

SPECIAL NOTES:

Project Name:

Revision Date:

Revision ID:

Location:

Area:

Representative:

Install Pattern:

Units:

Rep Email:

Scale:

Total Area:

Notes: Images are not drawn to scale